

Reference scale components 1 : 50

For further information see Architect's folder installation planning 6502100

Lines and pipes
above floor: continuous line
under floor: dotted line

Representation:
Red: customer provided performance / provided by the customer
Blue: CHRIST scope delivery
Black: foundation and building provided by the customer

Legend for network connections - installed by customer		
Pos.	Designation	Specification
LAN101	C-ST Premium network connection	Network cable Cat 6, with (RJ45) connection socket at C-ST Premium connecting point to LAN105
LAN104	C-IS/VENDOR network connection	Wet room network socket Ethernet (RJ45), IP 67, Cat 6 network connection with internet access, on the network cabinet
LAN105	C-ST Premium network connection	Network cable Cat 6, with wet room network socket Ethernet (RJ45), IP 67 at connection point external control cabinet to LAN101

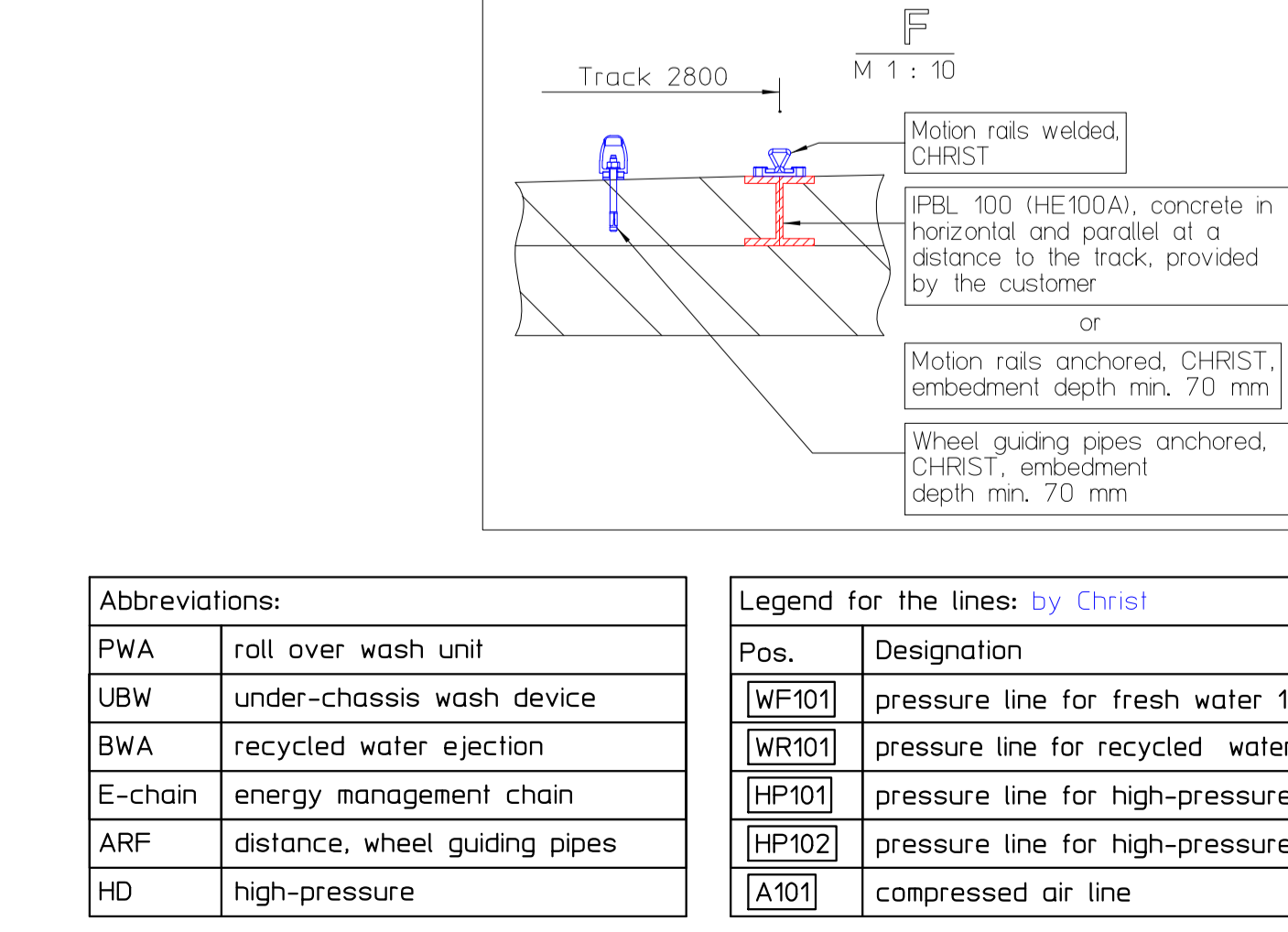
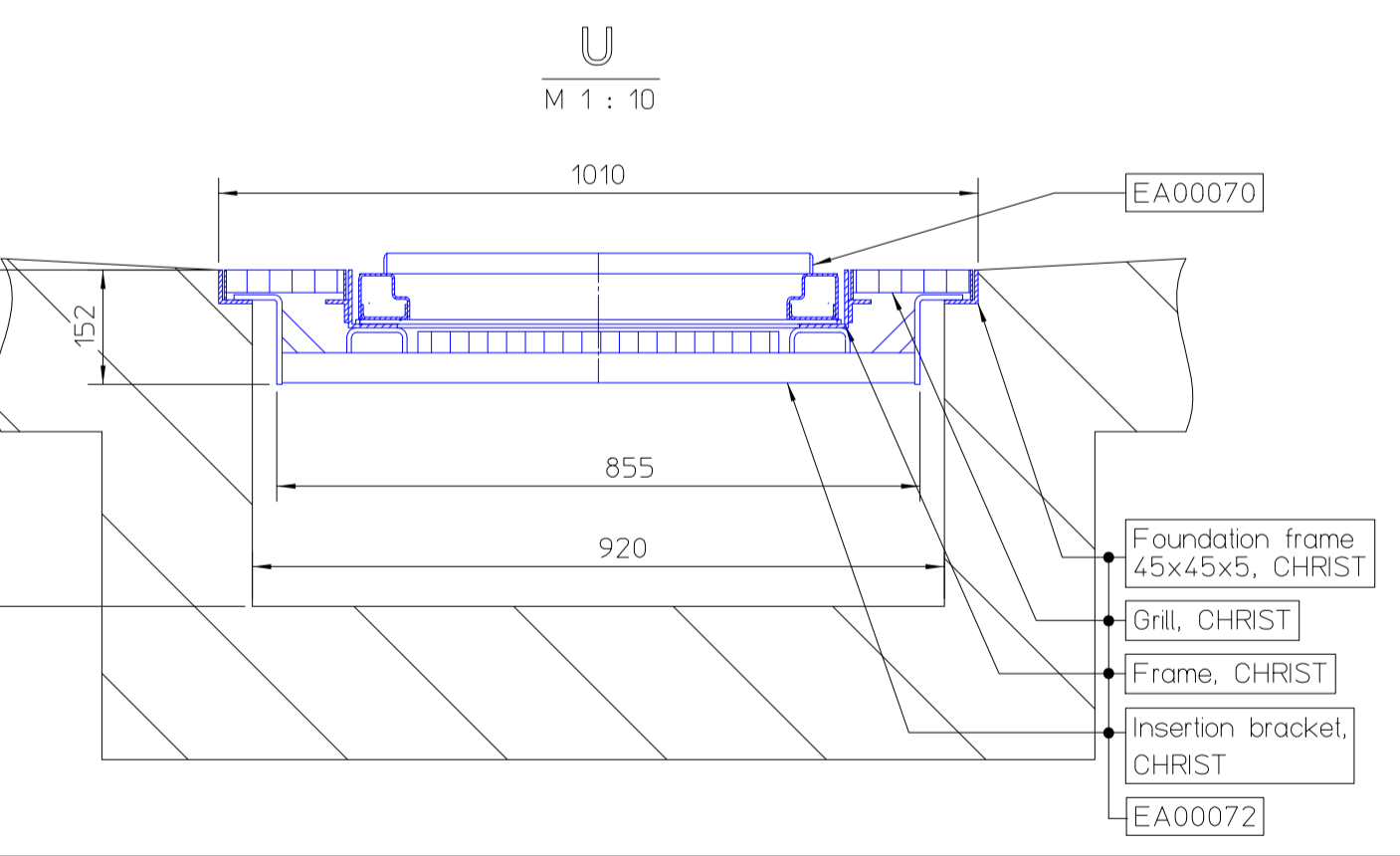
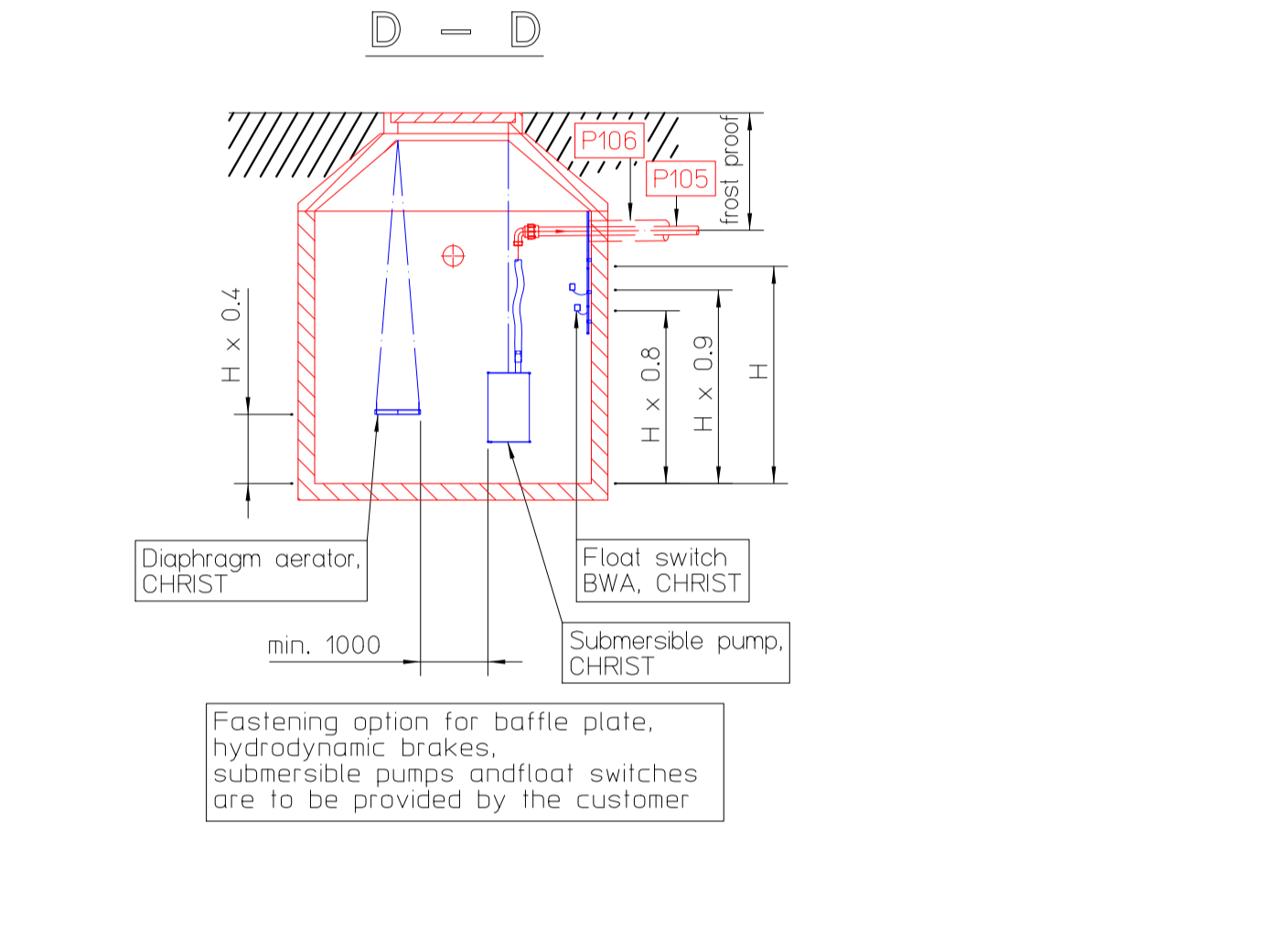
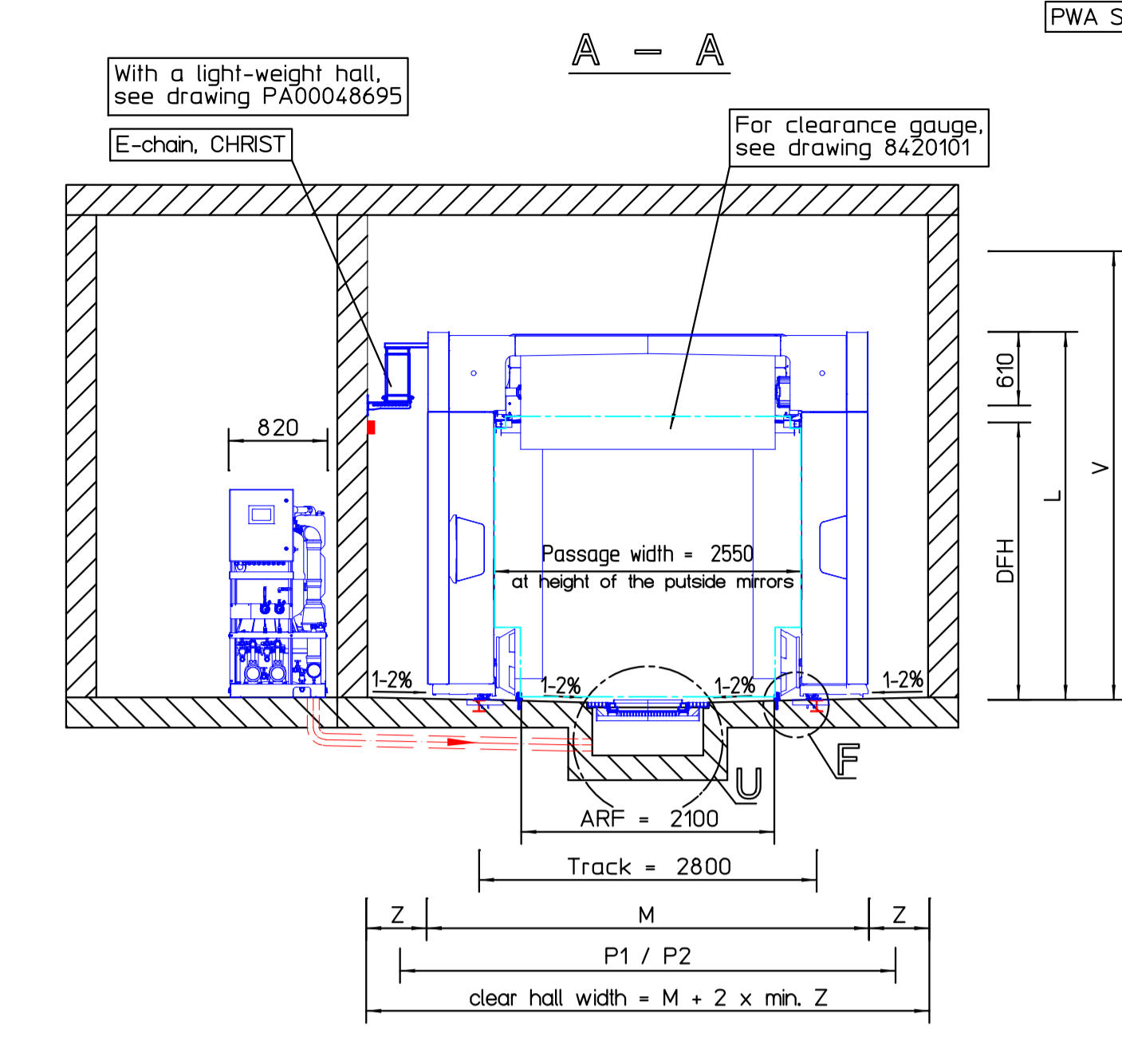
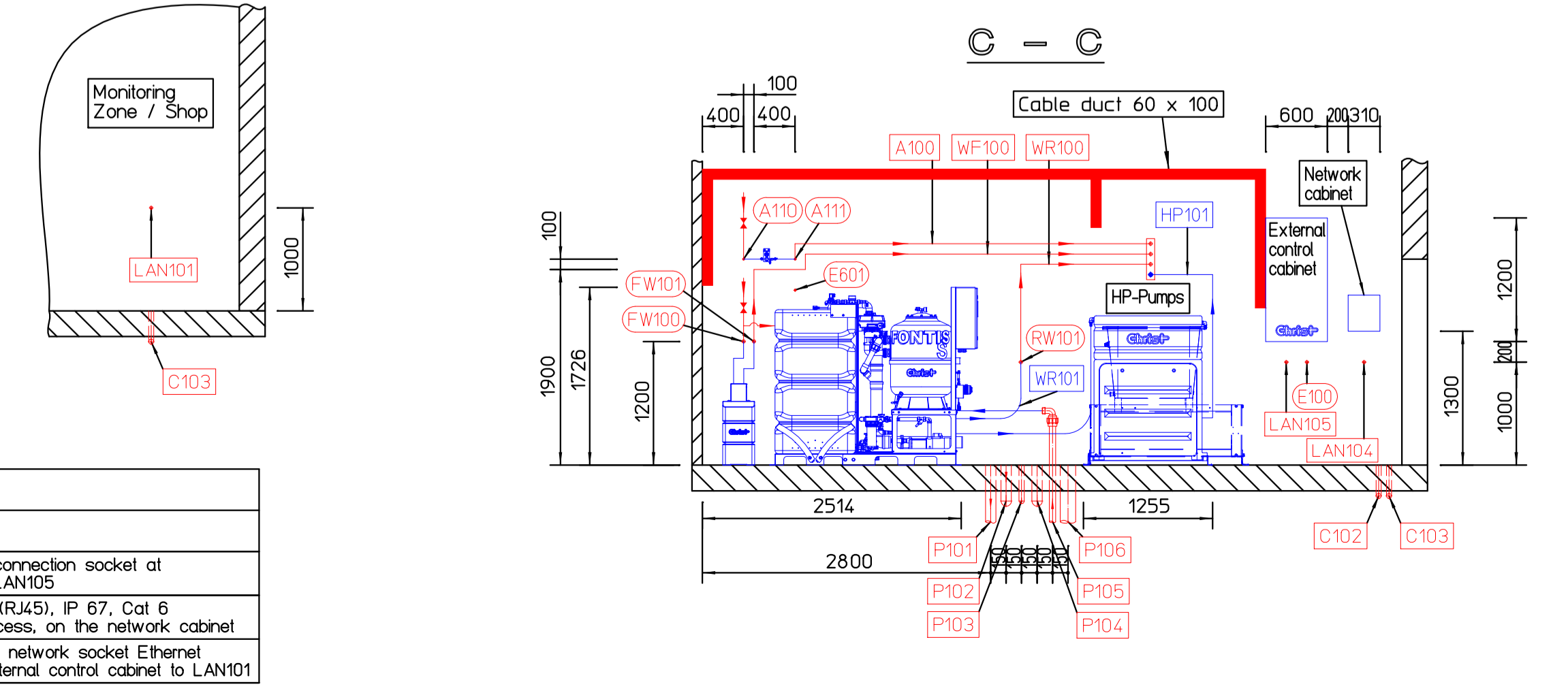
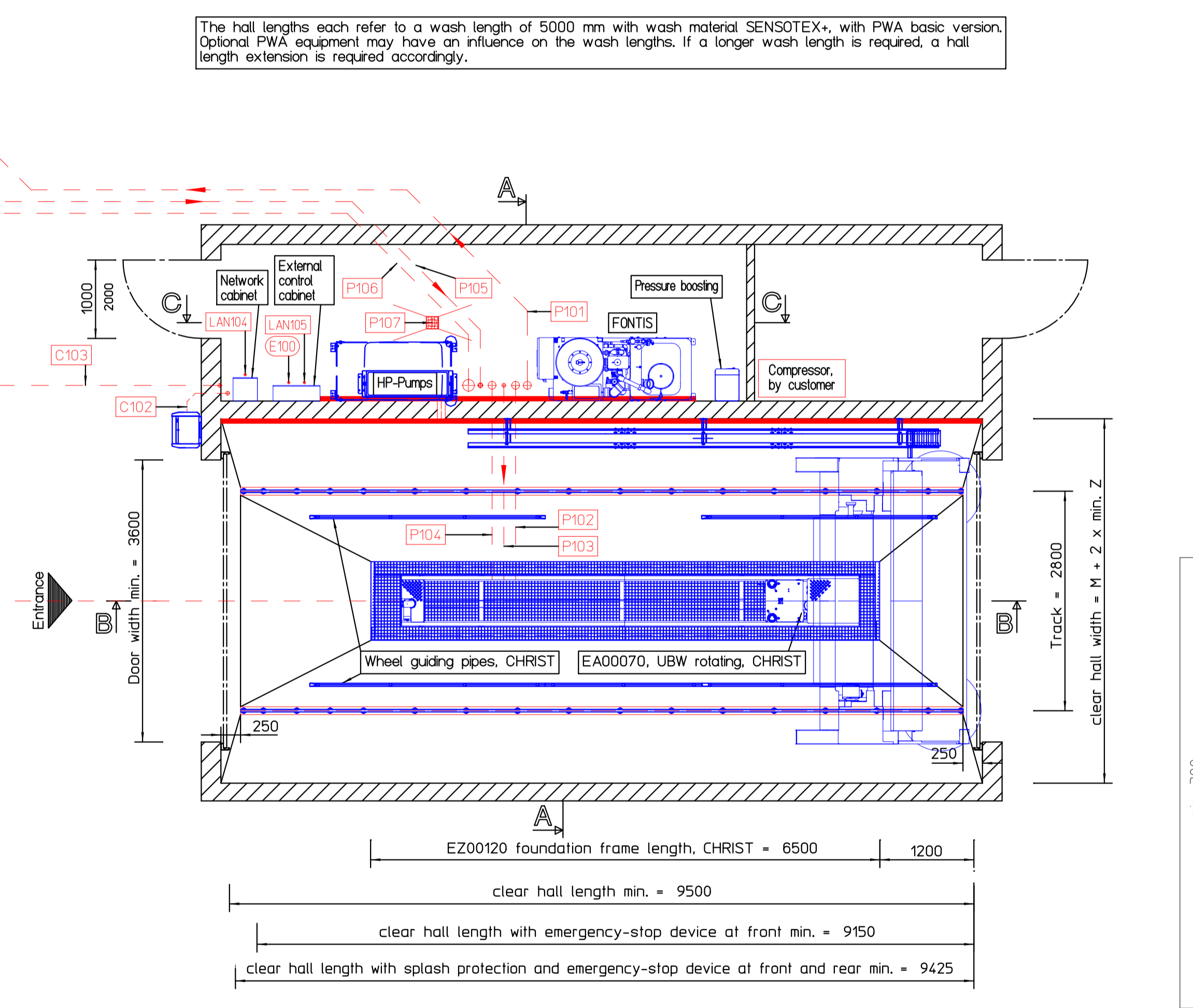
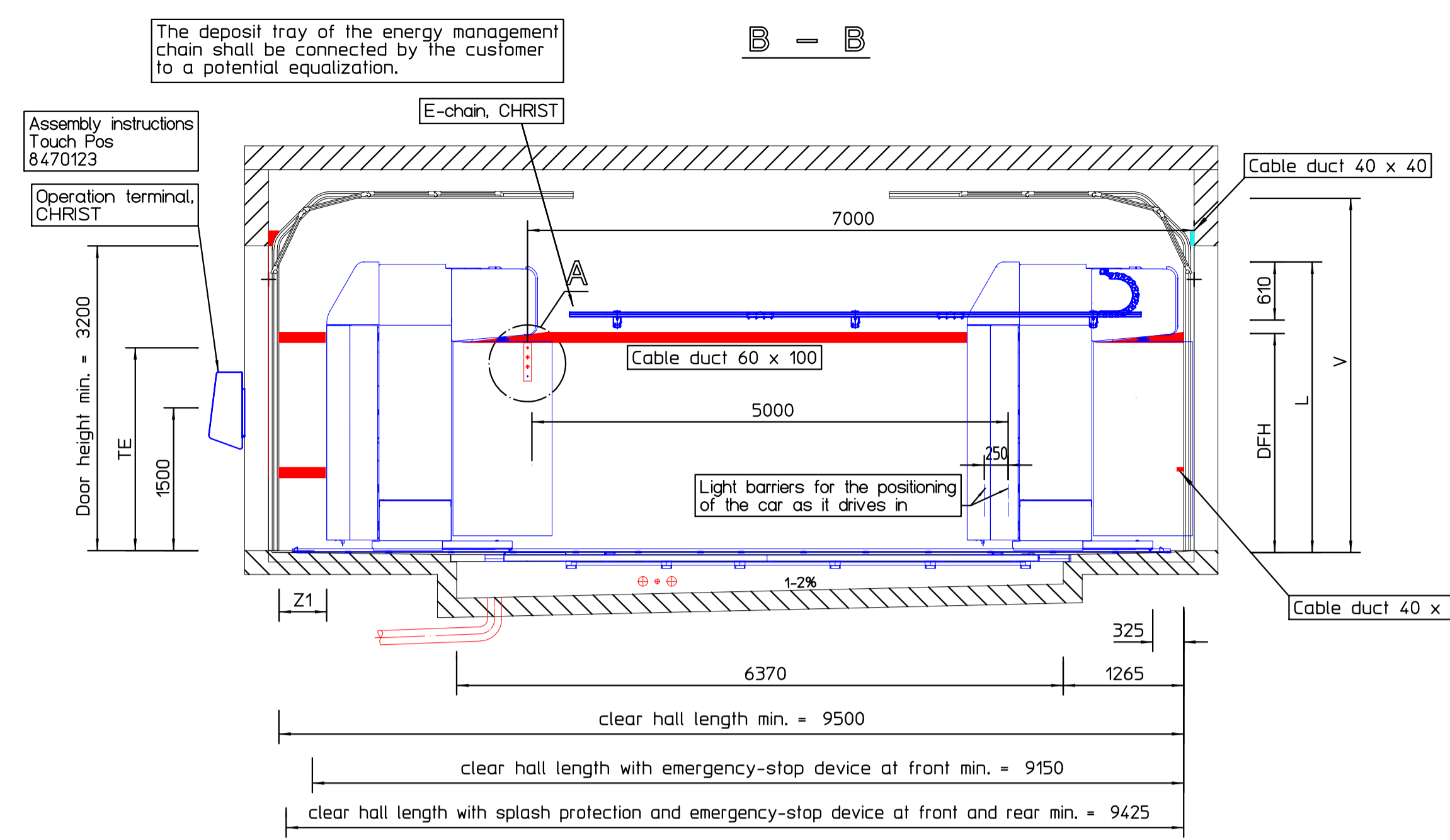

Abbreviations:

PWA	roll over wash unit
UBW	under-chassis wash device
BWA	recycled water ejection
E-chain	energy management chain
ARF	distance, wheel guiding pipes
HD	high-pressure

Legend for the lines: by Christ

Pos.	Designation
WF101	pressure line for fresh water 1
WR101	pressure line for recycled water 1
HP101	pressure line for high-pressure 1
HP102	pressure line for high-pressure 2
A101	compressed air line

Roll over wash unit ALPHA C173

	2300	2400	2500	2600	2700	2800	2900	3000	3100	3200
DFH passage height (with sluring platform or grill lane -> DFH - 50 mm)	3050	3150	3250	3350	3450	3550	3650	3750	3850	3950
L Machine height (with horizontal splash protection + 50mm)	3100	3200	3300	3400	3500	3600	3700	3800	3900	4000
V Clear hall height, min.	2400	2550	2700	2850	3000	3150	3300	3450	3600	3750
DFB Passage width	2050	2100	2150	2200	2250	2300	2350	2400	2450	2500
ARF Distance wheel guiding pipes	3520	3670	3820	3970	4120	4270	4420	4570	4720	4870
M Machine width max. - without splash protection	4060	4210	4360	4510	4660	4810	4960	5110	5260	5410
P1 required hall width without splash protection - with splash protection	410	4260	4410	4560	4710	4860	5010	5160	5310	5460
P2 required hall width with splash protection	420	4360	4510	4660	4810	4960	5110	5260	5410	5560
Track widths	2500	2700	2900	3100	3300	3500	3700	3900	4100	4300
Standard	2800	2900	3126	3200	3300	3400	3500	3600	3700	3800

TE	Connection height E-chain	2030	2130	2230	2330	2430	2530	2630	2730	2830	2930
Z	Safety distance 500 mm										
Z1	Safety distance without emergency-stop device 500 mm										
	Safety distance with emergency-stop device 150 mm										

Legend for supply connections and lines - installed by customer

Pos.	Designation	Specification
E100	Electric connection of PWA incl. supply pump up to max. 8,0 kW; supply pump up to max. 12,0 kW; supply pump up to max. 16,0 kW; supply pump up to max. 20,0 kW; supply pump up to max. 24,0 kW;	400 V, 3/N/PE, 50 Hz, cable with 2 m protrusion 16,0 kW, 32 A (with Turbo Dry 23,0 kW, 40 A) 18,5 kW, 35 A (with Turbo Dry 23,0 kW, 40 A) 23,5 kW, 44 A 28,5 kW, 53 A 33,5 kW, 62 A
E601	Electric connection of switchboard plant FONTIS-S.	3,5 kW, 400 V, 3/N/PE, 50 Hz, 7 A, cable with 2 m protrusion
FW100	Fresh water connection from the water network	Connection DIN EN 10226-1, Rp 1", inner thread, lockable, flow pressure 4 bar, delivery rate 100l/min.
FW101	Fresh water connection from the installations room into the wash hall	Connection DIN EN 10226-1, Rp 1", inner thread, lockable, flow pressure 4 bar, delivery rate 100l/min.
FW102	Fresh water connection wash hall	Connection DIN EN 10226-1, Rp 1", inner thread, flow pressure 4 bar, delivery rate 100l/min.
WF100	Fresh water pressure line	Flow pressure 4 bar, delivery rate 100l/min.
RW101	Recycled water connection from the installations room into the wash hall	Connection DIN EN 10226-1, Rp 1", inner thread, flow pressure 4 bar, delivery rate 100l/min.
RW102	Recycled water connection wash hall	Connection DIN EN 10226-1, Rp 1", inner thread, flow pressure 4 bar, delivery rate 100l/min.
WR100	Recycled water pressure line	Flow pressure 4 bar, delivery rate 100l/min.
A110	Compressed air connection installations room	Connection DIN EN 10226-1, Rp 1/2", inner thread, lockable, flow pressure 6 bar, delivery rate (of a piston compressor): 300 l/min. - plant with anti-frost / water emptying 200 l/min. - plant without anti-frost / water emptying
A111	Compressed air connection from the installations room into the wash hall	Connection DIN EN 10226-1, Rp 1/2", inner thread, lockable, flow pressure 6 bar, delivery rate 300 l/min.
A112	Compressed air connection wash hall	Connection DIN EN 10226-1, Rp 1/2", inner thread, flow pressure 6 bar, delivery rate 300 l/min.
A100	Compressed air line	Flow pressure 6 bar, delivery rate 300 l/min.

Legend for underground pipe an empty conduits - installed by customer

Pos.	Designation	Specification
P101	Outlet pipe FONTIS-S - BWA	DN 100, with gradient to the sewerage system
P102	Outlet pipe FONTIS-S - backwash	DN 100, with gradient to the UBW or sludge trap
P103	Empty conduit FONTIS-S - flocculant dosing	DN 50, with pulling wire and gradient to the UBW or sludge trap
P104	Empty conduit UBW	DN 100, with pulling wire and gradient to the UBW
P105	Pressure line FONTIS-S - wastewater, (with use of CHRIST-BIOCLEAR twin version)	DN 50 (HDPE-pipe 63x5,8 mm, PN6, DIN 8074/8075), connection: DIN EN 10226-1, Rp 2", inner thread, both on sides, gradient to discharge tank, max. length 25 m, geodetic height 3 m
P106	Empty conduit FONTIS-S supply line for discharge tank	KG 160, DIN 19534 (water-bearing), with pulling wire gradient to the discharge tank
P107	Outlet pipe installations room	DN 100, with gradient to the sludge trap
C102	Empty conduit for operation terminal	DN 50, if applicable with pulling wire to the external control cabinet
C103	Empty conduit for emergency-stop in the monitoring zone	DN 50, with pulling wire to the external control cabinet

- General pointers:
- This plan is a general one and cannot be used as implementation plan.
 - This plan is a reference for the architect / planner.
 - Inform the OTTO CHRIST AG about any deviation of the customer provided performances.
 - Specified dimensions in mm.
 - The specified dimensions concern the prefabrication.
 - The wash hall and the installations room shall be illuminated according to the regulations.
 - The wash hall and the installations room shall be sufficiently aerated and ventilated.
 - The sites of the wash systems and the technology must be frost proof.
 - The floor of the wash halls, wash bays and installations rooms shall be liquid-tight and skid-resistant.
 - Make sure that the elements / device placed in the wash hall and the installations room are sufficiently protected against corrosion.
 - The walls, paints, wall and floor tiles shall be resistant against the chemicals that will be used.
 - All lines and connections described in the legend must be provided by the customer and installed according to local regulations.
 - The outlet pipes, empty conduits and lines installed indoor and outdoor must be frost resistant.
 - Wash halls in light construction, a crossarm is required over the complete hall length to accommodate the E-chain.
 - In the work and traffic zone of the wash system, a safety distance of min. 500 mm shall be available between the wash system and the fixed parts of the surrounding, up to a height of 2000 mm over the stand area of staff. If the safety gap cannot be maintained, automatic safety devices are required.
 - In the work area of the wash system (= clear hall length, width and height) no disturbing contours are permitted due to parts provided by the customer.
 - The use of a water preparation unit, the model of the separator system and the waste water inlet line must be in accordance with local regulations and are subject to approval.
 - The recirculation and sewage pre-treatment of sewage water from the mechanical vehicle cleaning for discharge into the public drainage system in accordance with article 48 of the wastewater decree (AbWV0) must either take place via the sludge trap 5000 l, the discharge tank 5000 l and separator of class I in accordance with DIN EN 858-1, DIN EN 858-2 and DIN 1999-100.
 - Empty conduits must be closed by the customer after installation by CHRIST.
 - It is up to the customer to take protective measures as required by the public power supply company for the electrical cables. If a leakage current protection device is used, the electric supply line E1 type B (sensitive to all types of current) with min. 300 mA is the only one approved. Separate protective measures should be taken by the customer for the wash technique.
 - The CHRIST door control shall be connected to the one provided by the customer by the door manufacturer or an electrician ordered by the customer. The surveillance of the doors shall be ensured by means of the door control of the door manufacturer.
 - The electric supply lines provided by the customer must be connected to the CHRIST switch-board plant in accordance with the connection provisions specified by the local power supply company.
 - Subject to technical modifications.

OTTO CHRIST AG
WASH SYSTEMS
8782 WEINGARTEN
POSTFACH 1254 TELEFON 08331857-0

Datum	Name
20.05.21	Brehm
	Gepr.

Installation Plan
C173 ALPHA

8421173-EN

REV	Blatt
00	1